

# ULTIMATE REVERSE OSMOSIS SYSTEM

## INSTALLATION INSTRUCTION & OWNER'S MANUAL Ver 3.1



**APEC WATER**

 [FREE DRINKING WATER.COM](http://FREE DRINKING WATER.COM)  
All Rights Reserved © APEC Water Systems



Please keep this Owner's Manual for future reference.

It contains useful information on how to maintain and care for your  
APEC Reverse Osmosis water filter system.

## TABLE OF CONTENT

1.	<b>Installation:</b>	
	Preparation .....	page 1
	Filter housings assembly .....	page 5
	Feed water connection .....	page 6
	Drain saddle connection .....	page 10
	Faucet mounting .....	page 12
	Connecting the whole system .....	page 13
2.	<b>Maintenance:</b>	
	Filter change schedule & instructions .....	page 18
3.	<b>Owner's Manual - RO Basics:</b>	
	System flow diagram .....	page 23
	Input water pressure: most important factor .....	page 24
	TDS meter: testing your water quality .....	page 24
	Tank volume & delivery pressure .....	page 25
	Misc. topics .....	page 26
4.	<b>Trouble-shoot Guide:</b>	
	RO Head diagram .....	page 28
	Humming noise .....	page 29
	No water at dispensing faucet .....	page 29
	System slow shut-off .....	page 31
	TDS level higher than normal .....	page 33
	Filter housing is leaking .....	page 34
	Tank ball valve is leaking .....	page 35
	Pure water still taste like Tap water .....	page 35
	Air bubble in cup or bottle when filling .....	page 35
5.	<b>Other Information:</b>	
	AirGap Faucet Installation .....	page 36
6.	<b>Warranty</b> .....	page 38

***Thank you for choosing APEC reverse osmosis systems.  
You now own the finest water filter in America.***

**Please read and become familiar with instructions and parts needed before proceeding with the installation.**

(This manual is constructed for standard APEC Ultimate RO System. For RO-PH90, RO-PERM and RO-PUMP system installation, please refer to the included addendum.)

BEFORE INSTALLATION:

**Inspect the system:**

Please take the system and all the components out of the box. Inspect the system and all the connection fittings carefully, make sure nothing is damaged during shipping. If any part is cracked or broken, please do not proceed with the installation and contact APEC or your distributor for an exchange or diagnosis.

**Recommended tools list:**

- Variable speed drill
- Drill bit: **1/4"** (for the waste line), **1/8"** (as pilot, not mandatory), and **1/2"** (for standard faucet hole, air-gap faucet requires 1&1/4" hole)
- 5/8", 9/16" open-end wrench, or adjustable wrench, pliers
- Phillips screwdriver
- Utility knife, or scissors
- Teflon tape

**Operating Parameter**

- Operating pressure: 85psi maximum
- Feed water temperature: 40 – 100 degree F (4-37 degree C)
- **Do not** connect this unit to **hot** water source
- Install the RO in a sheltered environment, avoid exposure to hot and cold weather or under direct sun light.

**General Installation/Operation/Maintenance Requirements**

- Installation needs to comply with state and local laws and regulations.
- System must be installed indoor away from possible environmental damage
- Do not use with water that is microbiologically unsafe or of unknown quality without adequate disinfection before or after system. Systems certified for cyst reduction may be used on disinfected water that may contain filterable cysts.
- This reverse osmosis system contains a replaceable treatment component critical for effective reduction of total dissolved solids. The product water shall be tested periodically to verify that system is performing satisfactorily.

Copyright:

This manual is copyrighted by APEC Inc. Under the copyright laws, this manual may not be reproduced in any form, in whole or part, without the prior written consent of APEC Inc. Manual print ver. 3.1, 2015 Jun.

**Components included with the RO system:**

Make sure you have all these parts before starting installation.



1 RO system head with pre installed membrane



3 Pre-filters in 3 Housings



1 Storage tank

**Installation kit includes:**



1 Faucet with washers and nuts



1 Feed water adaptor 3/8" - 1/2" with needle valve kit



1 Drain saddle for waste water



3 Color tubing 1/4"



1 Tank's Ball Valve



2 Wrenches for opening filter and Membrane housing



1 Faucet Adapter

## Component Itemization:



- 1) Sediment pre-filter and housing (1<sup>st</sup>-stage filter)
- 2) Carbon block pre-filter and housing ( 2<sup>nd</sup>-stage filter)
- 3) Carbon block pre-filter and housing ( 3<sup>rd</sup>-stage filter)
- 4) Membrane and housing (4<sup>th</sup>-stage filter)
- 5) In-line carbon filter (5<sup>th</sup>-stage filter)
- 6) Storage tank
- 7) Tank ball valve
- 8) ASO – Automatic Shut Off valve
- 9) Check valve (Internal check valve encased in plastic fitting)
- 10) T-fitting
- 11) Feed water inlet
- 12) Product (filtered) water outlet
- 13) Bracket

**Fitting Types:** There are 2 types of fittings provided for connecting the system

1. **Quick-Connect (QC) fitting:** (no insert, sleeve, or nut) Most of the fittings on the RO unit are this type.

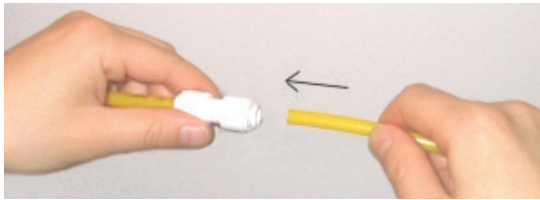

**Fig. 1**

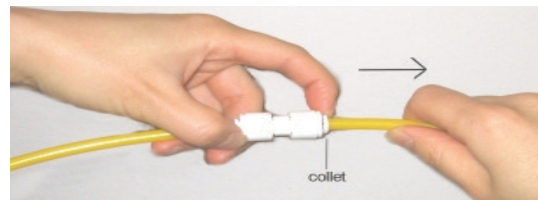

**Fig. 1A**

How to Connect: - See **Fig.1**. Push the tubing into the Quick-Connect fitting, then gently pull back on the tubing to make sure connection was secure.

- No inserts, sleeve, or nuts are needed to secure the connection.
- No Teflon tape!

To Disconnect: - See **Fig.1A**. Push in and hold down on the collet ring square against the fitting. With the collet held in this position the tube can be removed.

2. **Metal compression nut fitting:** (comes with 1 insert, 1 sleeve, 1 nut) Only feed water adapter-needle valve is this type.

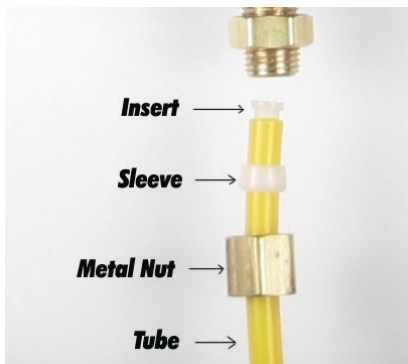

**Fig.1B**

**Important!** Use plastic sleeve and inserts on the plastic tubing we provide. Do Not use metal sleeve or insert on plastic tubing or the connection will leak!

How to connect: - See **Fig.1B**. Slide the compression nut onto the tubing.  
- Slide the **plastic sleeve** onto the tubing.  
- Insert the **"insert"** into the tubing.  
- Insert the tubing into the opening of the fitting.  
- Slide the brass nut up, then tighten nut with a wrench. No Teflon tape!  
(An extra metal sleeve is provided in case you need to connect your own metal tubing. Use Teflon tape if connecting metal tubing.)

## THERE ARE TWO PARTS TO INSTALLING THE RO SYSTEM:

- Part I. Assemble the filters and housings onto the main system
- Part II. Installing the system

**Note: The RO Membrane Element has already been pre installed.**

### PART I. ASSEMBLE THE FILTERS AND HOUSINGS ONTO THE MAIN SYSTEM

Remove plastic/paper wrappings on the 3 filters, put them into the 3 housings, and assemble the housings onto the main system as follow:

1. **See Fig. 2** Stand the 3 housings upright. Make sure each housing has a rubber O-ring in its groove.  
Put the APEC Sediment filter (1-SED10) into the "1<sup>st</sup> stage" housing on the right.  
Put the APEC Carbon filter (23-CAB10) into the "2<sup>nd</sup> stage" housing in the middle.  
Put the APEC Carbon filter (23-CAB10) into the "3<sup>rd</sup> stage" housing on the left.
2. **See Fig. 3** Starting from the 3<sup>rd</sup> stage housing on the left, hand twist the housing onto the main system turning counterclockwise, one by one, for all 3 housings.
3. **See Fig. 4** Use the wrench provided to completely tighten the housing starting from 1st-stage. Repeat this step for the 2<sup>nd</sup> stage housing in the middle, and for the 3<sup>rd</sup> stage housing on right.

**Note:** For some people it is easier to use the wrench with the system laid down (face up).

4. **See Pg. 3** Remove 3 end plugs (white color) from Point 10,11,12

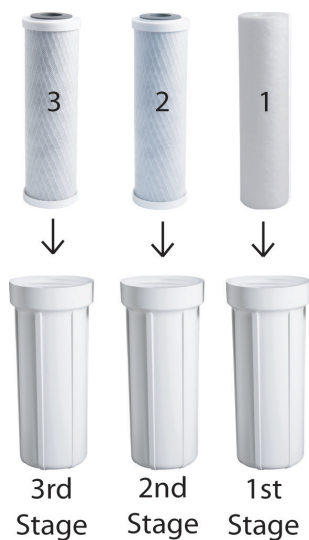

Fig. 2

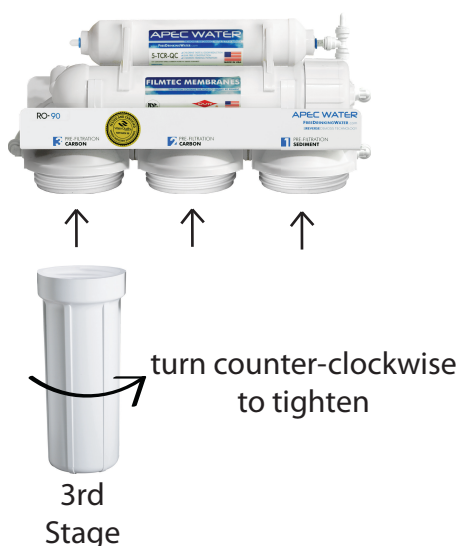

Fig. 3

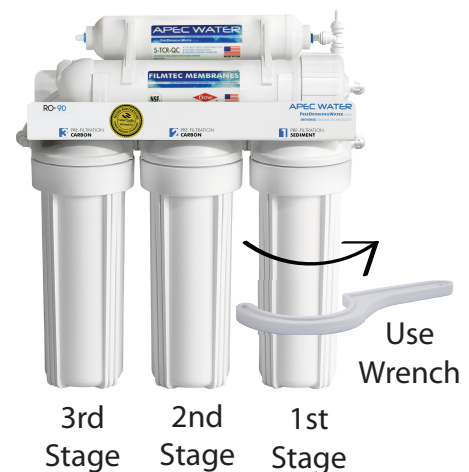

Fig. 4



## PART II. INSTALLING THE SYSTEM

**Space:** Make sure there is sufficient space under the counter for installation (an area of about **17”L x 6”W x 18”H** for the system, **11”D x 18”H** for tank).

The RO system is best installed under the kitchen sink. But if that is not feasible you can install the system anywhere where there is a cold water supply with sufficient water pressure for the chosen RO model, and an outlet to drain off the waste water from the system.

**Mounting:** No need to mount the RO system on the wall. The RO system can stand in the sink cabinet without mounting, this makes future filter change easy and convenient. If you prefer to mount the system to the wall, please make sure it can be taken down easily for filter replacement.

**Feed Water:** RO systems are designed to treat both hard and soft water and can handle incoming TDS levels up to 2000ppm.

### Step 1: Feed Water Connection

**The RO system must be connected to the COLD water supply only!**

1. Locate the **Cold** water supply valve under the kitchen sink (the round or oblong handle on the right side). Turn off the incoming cold water completely by turning the shut off handle clockwise.

**Note:** If the cold water shut off valve can not turn off the water, the main water supply to the house must be shut off for the installation. Another option is to use a “self piercing saddle valve” from APEC or from a local hardware store.

2. **Feed Water Adaptor (1/2” to 3/8”):** See **Fig. 5**. The Feed Water Adaptor comes with a separate Needle Valve. The Adaptor goes inline onto your 1/2” or 3/8” cold water pipe. The Needle Valve portion screws onto the Adaptor as shown in **Fig. 5A**.



**Fig. 5**

- A. 1/2” x 3/8” Male-Female Water Supply Adaptor with O-ring.
- B. 1/2” x 3/8” Male-Female Converter with O-ring.
- C. 1/4” x 1/8” Male Needle Valve.

**Fig. 5A - Needle Valve Installation.**

Attach the needle valve (C) to water supply adapter (A). Please apply 5-6 wraps of teflon tape to needle valve prior to connecting it to the water supply adapter (A).

**Fig. 5B - If your pipe has a 1/2" Connection.**

By attaching the 1/2" x 3/8" converter (B) to the Male end of the water supply adapter (A), you now have a 1/2" Male and Female water supply adapter.

**Fig. 5C - If your pipe has a 3/8" Connection.**

By attaching the 1/2" x 3/8" converter (B) to the Female end of the water supply adapter (A), you now have a 3/8" Male and Female water supply adapter.

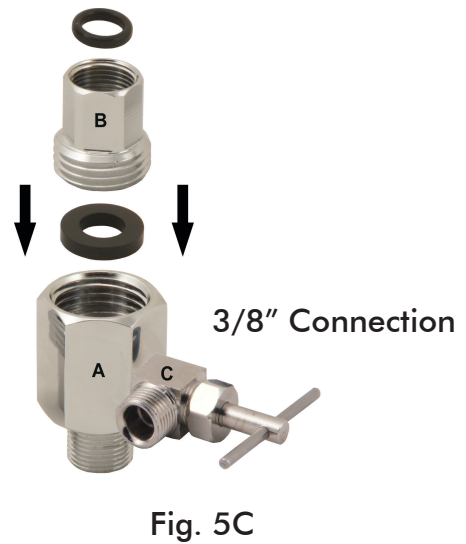
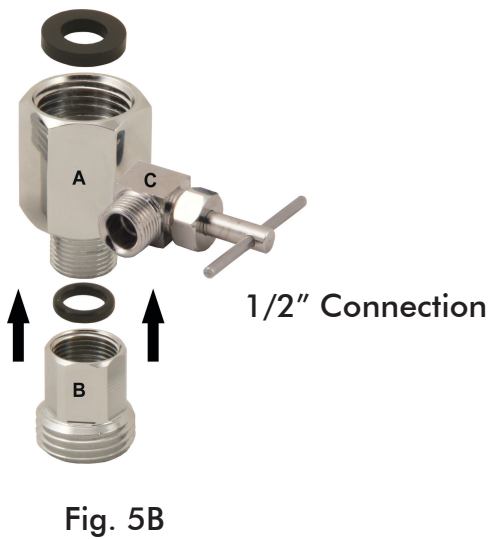
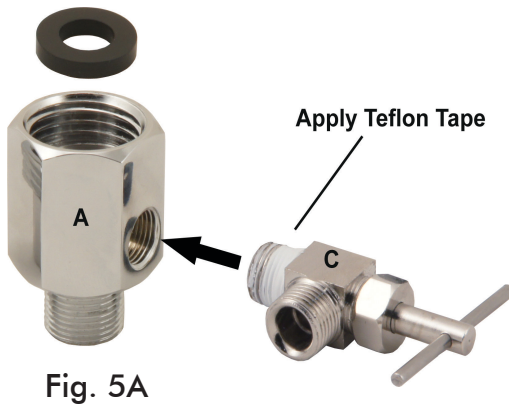

3. **Recommend Connection For Flex Line Riser:** See Fig.6A. & Fig. 6D. Loosen nut and separate cold water riser tube from faucet shank. Gently bend riser tube so that the Feed Water Adapter (Fig 5) fits onto the faucet shank. If your riser tube has no built-in washer, then fit the cone-shaped washer provided onto the riser tube. Connect the riser tube, the feed water adapter, and faucet shank together and **tighten**.

**For Solid Copper Riser:** See Fig.6B. Follow the same procedure as for flex line. If the copper riser cannot bend, then it's best to replace it with a flex line riser. Then fit the feed water adaptor the same way as described above.

**Option Connection Point:** See Fig. 6E. The feed water adapter can also be installed between the riser tube and faucet shank. Loosen nut and separate cold water riser tube from faucet shank. Gently bend riser tube so that the Feed Water Adapter fits onto the faucet shank. If your riser tube has no built-in washer, then fit the cone-shaped washer provided onto the riser tube. Connect the riser tube, feed water adapter, and faucet shank together and **tighten**.

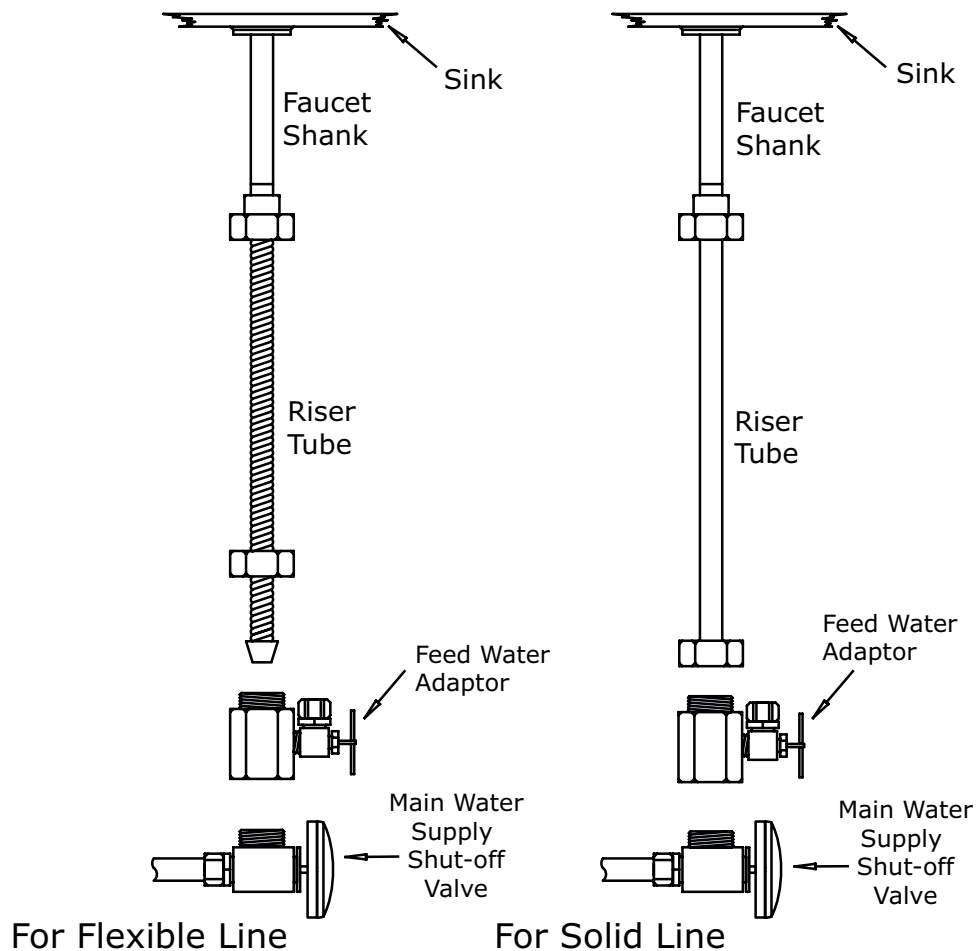

Fig. 6A

Fig. 6B

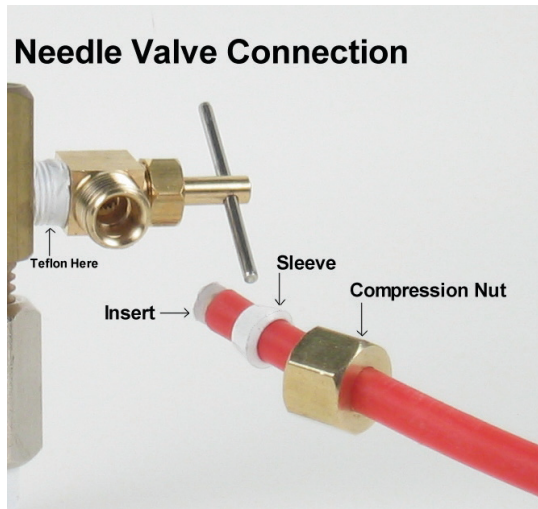

Fig. 6C

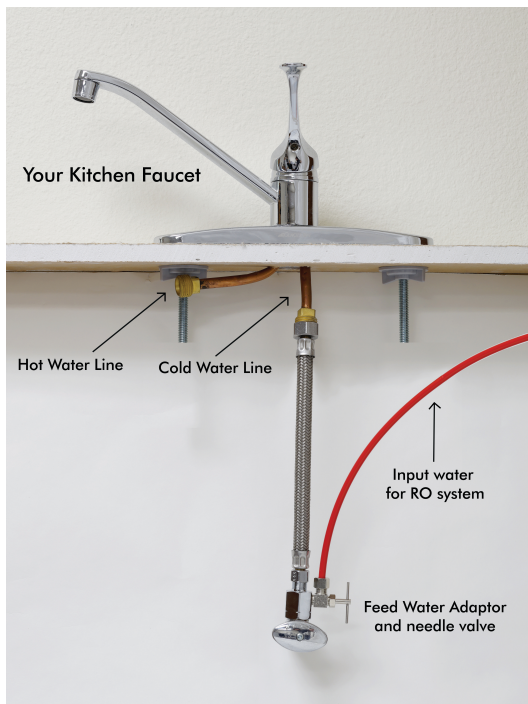

Fig. 6D

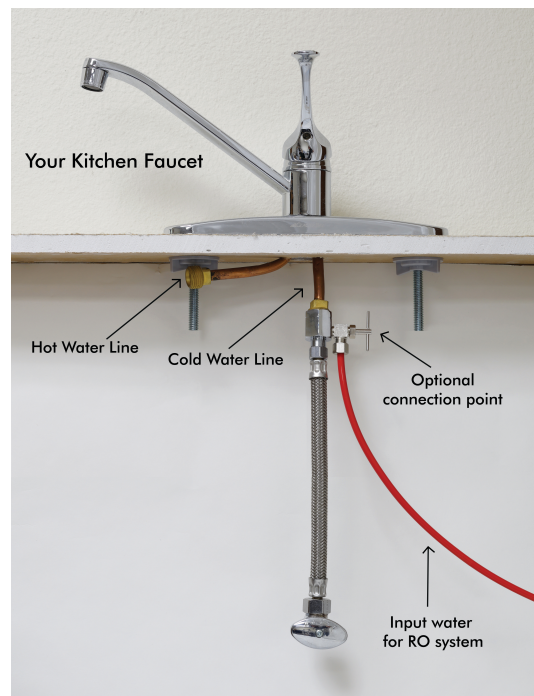

Fig. 6E

4. **Needle Valve:** See Fig. 6C. Screw the Needle Valve onto the Adaptor tightly. Apply 6-8 rounds of Teflon tape onto Needle Valve before attaching it to the Adaptor.

To **open** needle valve: Turn needle handle counter-clockwise.

To **close** needle valve: Turn needle handle clockwise.

Test for leaks at this point: Close the Needle Valve (turn needle handle **clockwise** all the way in to close) Turn ON the cold water supply to the sink faucet. If the Needle Valve or the Adaptor leaks, check the connection and try applying more Teflon tape or tighten the brass nut some more to stop the leak.

## Step 2: Drain Saddle Installation

**Note:** To avoid annoying drainage noise, mount drain line as low as possible on the vertical tailpiece, or on horizontal tailpiece.

There is constant water pressure “packed” inside the RO system which blocks the waste water from backing-up into the system. So the waste water is “forced-drained”, not “gravity-drained”.

1. See **Fig.7**. The drain saddle assembly should be installed above the trap and on the vertical or horizontal tailpiece . To reduce the drainage noise, mount the drain line as low as possible above the trap, or on the horizontal tailpiece.

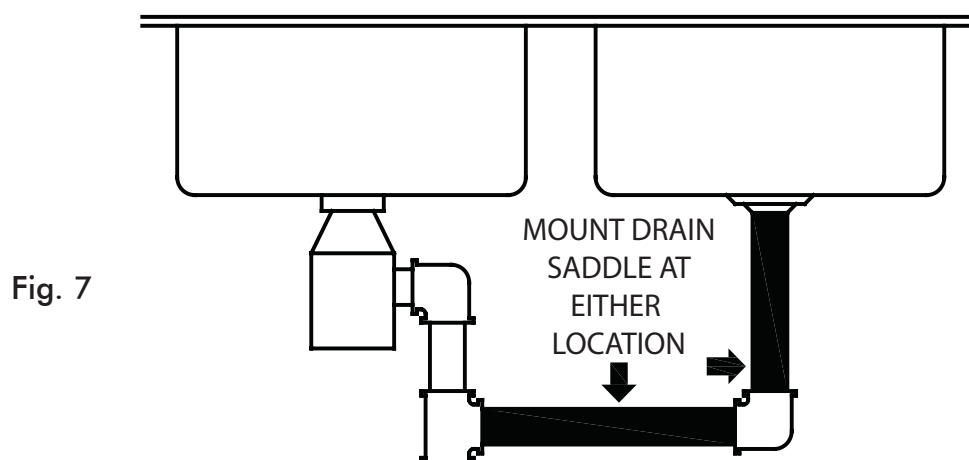

2. See **Fig.8**. Mark the position of the hole on the drain pipe and drill a 1/4" hole through one side of the drain pipe . There is a piece of self-adhesive sponge provided. Glue this sponge to the inside of the saddle, this will cushion any gap between the saddle and the pipe. Make sure the hole on the sponge is thoroughly punched out, and is aligned to the hole on the saddle.



Fig. 8



Fig. 9

3. See Fig.9, 9A. Make sure to align the drain saddle hole to the drilled hole perfectly. Mis-aligning these two holes will block the waste water and cause membrane damage. Attach the drain saddle to the drain pipe and tighten the two screws evenly.



Fig. 9A

### Step 3: Drill A Hole For The RO Faucet

Drill 1/2" diameter hole for standard RO faucet. (Air-Gap faucet: drill 1&1/4" hole.)

For best results use a 1/2" carbide-tipped masonry drill bit.

Wear safety glasses to protect your eyes while drilling the faucet hole.

**Note:** No need to drill a hole if an existing hole is available:

- a) **Spare hole:** If there is a spare hole in the sink covered by a chrome cover, simply remove the chrome cover and install the RO faucet there.
- b) **Spray hose:** If the spray hose is not in use, remove the hose, and mount the RO faucet there. Remember to plug up the outlet under the main faucet. If the spray hose uses a diverter at the base of the spout, be sure to remove it to avoid trouble later on.
- c) **Hanging faucet:** If drilling a hole is not feasible (i.e. rental home, drill tool not available etc.), the faucet can just on the cabinet door or wherever that is convenient. Be creative!

When drilling a hole for the RO faucet, choose a location that looks good, works well, and is most convenient for dispensing pure water. An ample flat area is required for the faucet base so that the faucet can be drawn down tightly.

1. **Faucet location:** Make sure the faucet stud will be accessible from below when the hole is drilled. If space is not available on the upper sink area, the faucet can be located on the counter top by the edge of the sink. If the counter top is ceramic tile, the method for drilling the hole will be the same as for porcelain sinks.
2. **For Stainless Steel Sink:** Before using a 1/2" carbide drill bit, an indent should be made with a center punch to keep the drill bit from walking. A small pilot hole will also aid the drill bit.

3. **For Porcelain Sink:** Porcelain enameled sinks can readily be chipped if care is not exercised when drilling the hole. Before starting the drill motor, apply firm downward pressure on the bit until a crunching occurs. This will help keep the drill bit from walking when starting the hole. A small pilot hole will also aid the drill bit.

**Note:** Immediately after the hole drilling is done, clean up all metal chips, as **metal chips will stain the porcelain!!**

#### Step 4: Mounting The Faucet

1. Mount the faucet as shown in **Fig.10**.
2. Attach threaded end of faucet adapter to the faucet metal stem. No teflon tape needed here.
3. Connect the **Clear** line to the faucet.
3. The faucet has a solid metal handle that controls the flow of purified water exiting the faucet. Turn the handle to horizontal position to release the water and vertically to shut off.

Fig. 10

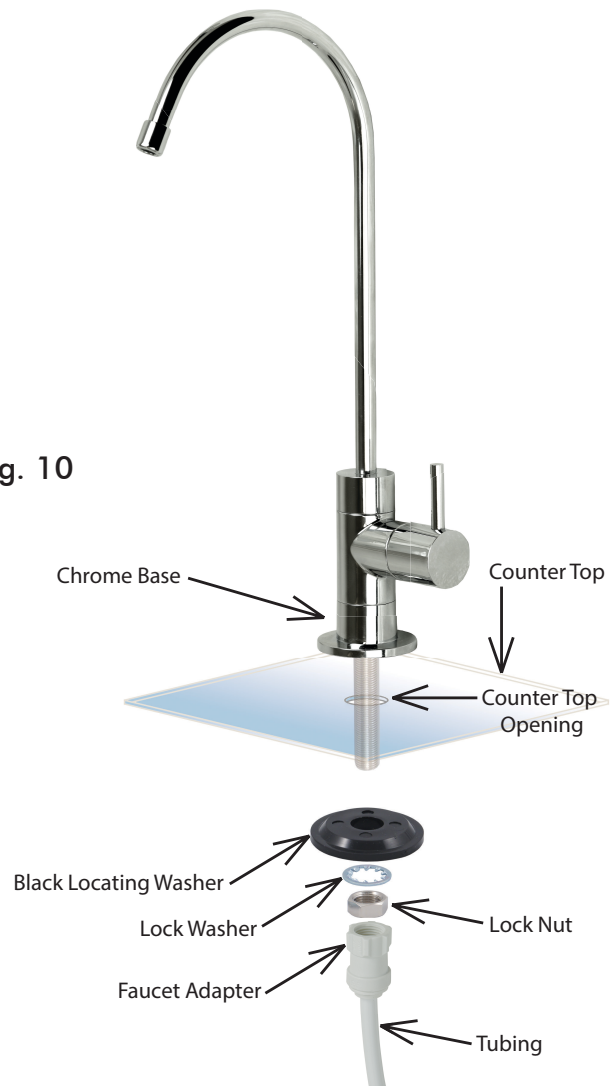

#### Step 5: Positioning The System

1. **Main System:** The main system can stand in the sink cabinet. No need to mount the system to the wall. If you prefer to mount the system to the wall, please make sure it can be taken down easily for filter replacement.
2. **Tank:** The storage tank can also lay on its side if needed. The tank works fine in this position. If the tank cannot fit under the kitchen sink, it can be placed elsewhere up to 20 feet away from the RO system without much pressure loss.

## Step 6: Connecting The System

### Summary of Tubing Connections:

There are 4 connections: See Fig 11 and 11A

Point **A** to **X**: Connect RO to COLD water supply — **Red** tubing.

Point **G** to **Y**: Connect product water from 5<sup>th</sup>-stage filter to tank — **Yellow** tubing. This tubing is a 2-way line, Product water enters and leaves the tank via this line.

Point **H** to **Z**: Connect product water from 5<sup>th</sup>-stage output to RO faucet — **Clear** tubing.

Drain line to **W**: Connect waste water from 4<sup>th</sup>-stage membrane to drain outlet — **Black** tubing.

**Please Note:** The diagram below is for our Non Pump RO-45, RO-90 and RO-PH90. If you are installing the RO Perm or RO Pump, please refer to the diagram in the addendum.

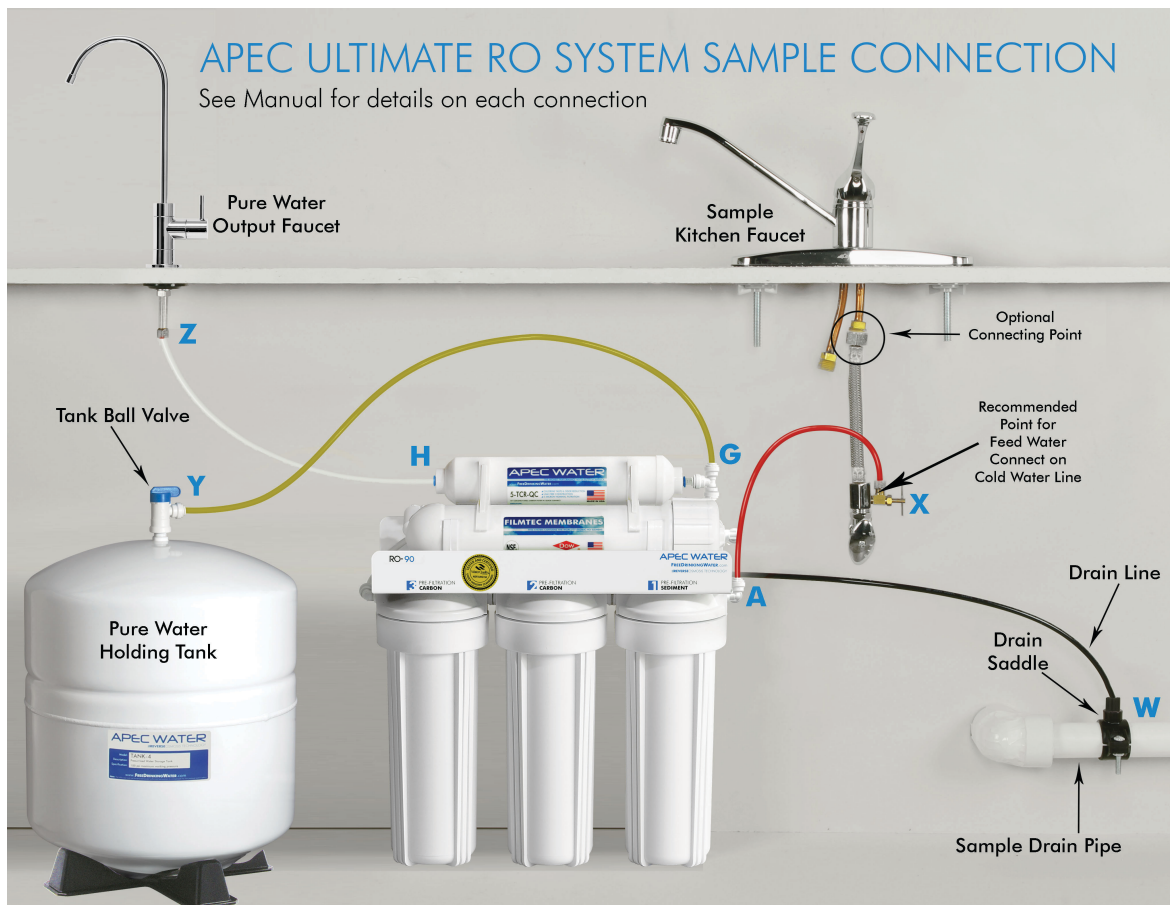

Fig. 11



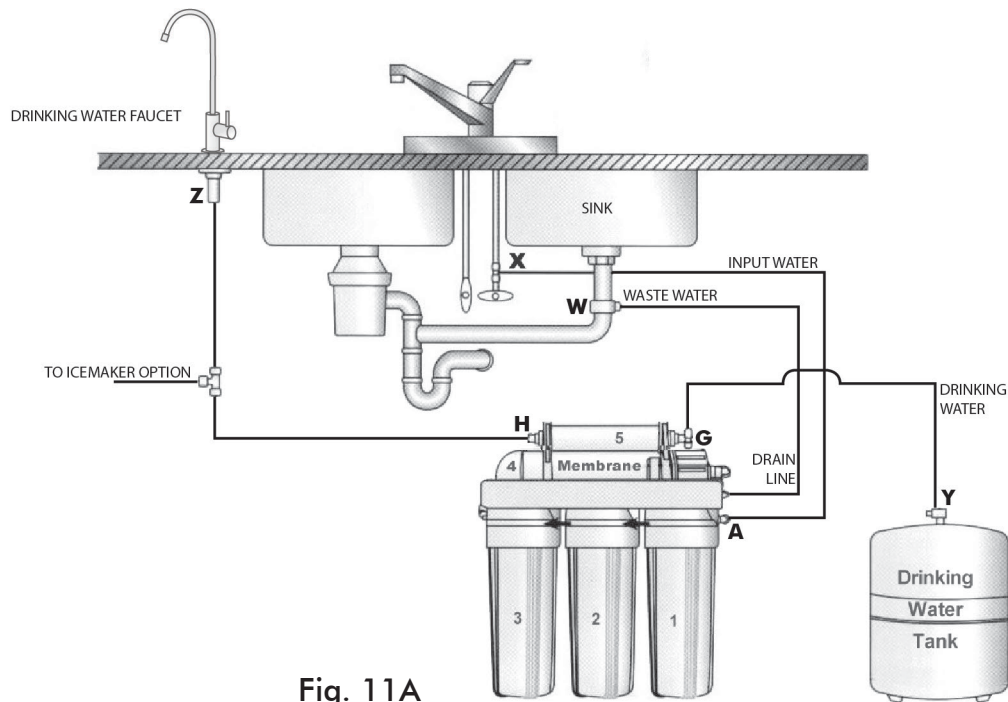

Fig. 11A

### Details on Tubing Connections:

To ensure a smooth and correct installation, please connect the water lines **following the sequence and order** outlined below. Refer to **Fig.11 & 11A** for proper point locations.

#### 1. Point Z Faucet connection:

Tubing color: Clear tubing. Connect the CLEAR tubing to the base of the RO faucet.  
 Fitting type: Quick Connect Fitting. Simply push Clear tubing into Quick Connect fitting. No Insert, Sleeve or Nut needed here. (Attach threaded end of faucet adapter to the faucet metal stem. No teflon tape needed here)

#### 2. Point X Feed water connection:

Tubing color: Red tubing. Connect the RED tubing to the Feed Water Needle Valve.  
 Fitting type: Metal compression nut fitting. See **Fig.1B** on **page 4**. Use **plastic sleeve**. Add **"insert"** to tubing. No teflon tape here. Tighten nut with wrench.

**Tips!** If **Point X leaks** after you have tightened the brass nut, check to make sure you did put the plastic **"insert and sleeve"** onto the tubing. If the insert is already in place, then try applying Teflon tape from the threaded metal stud all the way to the plastic tubing, wrap the whole connection with 8-10 rounds of Teflon tape. Smooth out the tape on the threaded part with your fingers. Tighten brass nut again. This should stop the leak.

If the plastic sleeve is damaged, you can use the metal sleeve, but you need to apply Teflon tape as described above, this should stop the leak.

### 3. Point W Waste water connection:

Tubing color: Black tubing. Connect the BLACK tubing from the RO to the Drain Saddle.

Fitting type: Quick-Connect fitting on drain saddle. No teflon tape.

**Do Not** add "insert" into Black tubing. Simply push tubing into port.

### 4. Point A System water inlet (to Stage 1 prefilter) connection:

Tubing color: Red tubing. Connect the RED tubing from the Feed Water Valve to the RO's stage -1 prefilter.

Fitting type: Quick Connect fitting **See Fig.1** on **page 4**. Simply push the Red tubing into the Quick Connect fitting. No Inserts, Sleeves or Nuts are needed to secure the connection. No teflon tape needed here.

### 5. Point H Stage-5 filtered water to faucet connection:

Tubing color: Clear tubing. Connect the CLEAR tubing from the faucet base stud to the Stage-5 filter's *outflow* end at **point H**. (See "Flow -->" arrow on the filter for flow direction.)

Fitting type: Quick Connect fitting **See Fig.1** on **page 4**. Simply push the Clear tubing into outlet on the 5th stage filter. No Inserts, Sleeves or Nuts are needed to secure the connection. No Teflon tape needed here.

**Please Note:** *There are two end plugs on the stage 5 filter that has to be removed before inserting the tubing. Please refer to Fig. 1A on page 4 for removal instruction.*

### 6. Point G Stage-5 filter's T-fitting connection:

Tubing color: Yellow tubing. Connect the YELLOW tubing to Stage-5 filter's T-fitting.

Fitting type: Quick Connect fitting **See Fig.1**. Simply push the Yellow tubing into the 5th stage filter's T Fitting. No Inserts, Sleeves or Nuts are needed to secure the connection. No Teflon tape needed here.

**(Note:** If the unit comes with a **UV Light**, connect the Yellow tubing to the T- fitting on the UV, as the Stage 5 filter will not have a T-fitting).

## 7. Point Y Tank's input & output connection:

Prepare tank: See **Fig. 12**. Apply 6-8 wraps of Teflon tape to tank's threaded Output stem on top of tank (remove rubber cap if there is one). Screw tank Valve onto Output stem.

Tubing color: Yellow tubing. Connect the YELLOW tubing from Stage-5 T-fitting to the tank's valve.

Fitting type: Quick-Connect fitting on ball valve. Simply push Yellow tubing into valve port.

Air pressure: The 4 gallon tank comes **pre charged** at 5 psi, 14 gallon tank at 7 psi.

### Standard 4-gallon Tank Diagram:



### Option: Ice-maker Connection

If you want to connect product water from the RO to your ice-maker, you will need:

- One T-fitting, preferably the quick-connect type fitting
- Extra 1/4 " tubing long enough to go from the RO system to your ice-maker
- Optional: One shut-off valve, preferably the quick-connect type.

See **Fig. 13**. Before connecting the product water line from Point **Z** to **H**, add a T-fitting near point **H** to divert product water to both the ice-maker and the faucet. It is best open the line to the ice maker **after** the first tank has been discarded and the 2nd tank has completely filled.

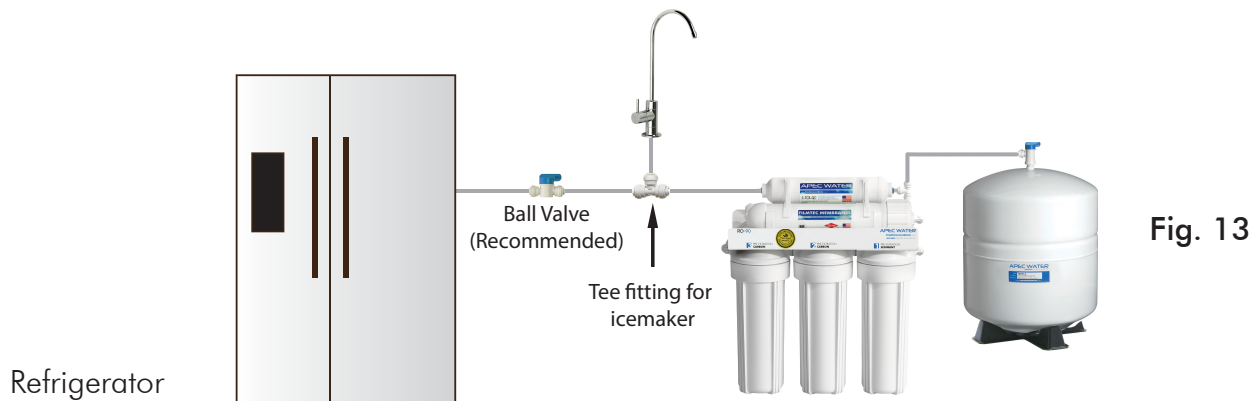

## Using RO for Ice-maker only:

If you want the RO to feed your ice-maker (fridge) only, **you should still connect the RO faucet as a 2nd outlet**. This allows you to drain the tank, flush new filters through the faucet rather than through your icemaker line. You can hang the faucet by the system and not mount it.

## Option: Multiple Outputs - Add Shut Off Valve:

If your RO is feeding several output points (icemaker, fridge, bathroom), you should add a **Shut-Off valve** to each output line (except the RO spigot line). This way, if you ever need to diagnose a problem in the system, you can easily shut off these lines to isolate the water flow for accurate troubleshooting.

## Step 7: System Start-Up

1. **Turn on feed water:** Slowly, turn on your Cold water supply. Turn on the Needle Valve (turn **counter-clockwise**) to allow the raw water to enter the system. **Check for leaks!**
2. **Turn on tank valve:** Turn on the tank's ball valve to allow water to enter the tank. The tank's valve is "**On**" when the valve handle is parallel (in the same direction) with the valve's outlet (see Fig.12). **Check for leaks!**
3. **Wait for tank to fill:** Before usage, allow the tank to fill. Tank normally takes **2-3 hours** to fill. When the tank is filled, the RO will shut off automatically.
4. **Drain Tank:** **Do not use the first tank of water! Drain it out to flush the system and new filters.** Lift the faucet lever up into a locked position to drain tank. Let the tank refill again and the pure water is ready for use.
5. **Clean up area:** Allow the system to run while cleaning up tools and work area.
6. **Check for leaks!** Make sure **no leaking** at joints, fittings, valves, and tubing connections.

***Congratulations! You have successfully installed the Reverse Osmosis System!***

**Note:** If your RO makes an annoying noise. See Troubleshoot Guide section for explanation and instructions on page 29.

\* \* \* End Installation Section \* \* \*